

AGS Vic®-300 Butterfly Valves

Series W761

(300 PSI/2065 KPA)



20.06



AGS Vic-300 butterfly valves 14 – 24"/350 – 600 mm are available with a standard hand wheel gear operator. Memory stops and chain wheels are available options, as are electric, pneumatic or hydraulic actuators in two or three-way configurations.

AGS Vic-300 valves are designed for direct connection with Victaulic AGS grooved couplings. Request publication [20.02](#) for W07 AGS rigid or [20.03](#) for W77 AGS flexible coupling information.

Approvals/Listings:



[See Victaulic Publication 10.01 for more details.](#)

Product Description:

The AGS (Advanced Groove System) Vic-300 grooved end butterfly valve offers an easily installed choice to cumbersome, multi-bolt wafer or lug-type flanged valves. The valve offers excellent flow characteristics with low torque operation. The resilient EPDM seat is rated for water services up to +230°F/+110°C. For services with oil content, the valve is available with Grade “T” nitrile seat, rated for petroleum, air with oil vapors, vegetable and mineral oils up to +180°F/+82°C. For services with oxidizing acids, petroleum oils, halogenated hydrocarbons, lubricants, hydraulic fluids, organic liquids and air with hydrocarbons to +300°F/+149°C, the valve is available with a Grade “O” fluoroelastomer seat.

The offset disc is polyphenylene sulfide (PPS) coated for corrosion resistance. It securely retains the resilient seat for bi-directional working pressure to 300 psi/2065 kPa.

The single piece body is cast of durable ductile iron (ASTM A-536, Grade 65-45-12), as is the narrow profile disc. The disc rides on a stout stainless steel (age hardened 17–4 PH) cross bolt and upper and lower stems with all other wetted hardware of Series 300 stainless steel construction.



WARNING

- **Victaulic AGS products use a patented groove profile that requires the use of special AGS rolls. AGS products must not be used on pipe that has been grooved using original grooving rolls.**

Failure to use AGS products on AGS grooved pipe could result in serious personal injury, property damage, joint leakage or joint separation.

Job/Owner

System No.	
Location	

Contractor

Submitted By	
Date	

Engineer

Spec Section	
Paragraph	
Approved	
Date	



Material Specifications:

Body: Ductile iron conforming to ASTM A-536, Grade 65-45-12

Body Coating:

Black polyphenylene sulfide (PPS) coating, UL classified in accordance with ANSI/NSF 61 for cold +86°F/+30°C and hot +180°F/+82°C potable water service

Disc: Ductile iron conforming to ASTM A-536, black PPS coated

Seat: PPS coated

Disc/Seal¹:

Grade "E" EPDM

EPDM (Green color code). Temperature range -30°F to +230°F/-34°C to +110°C. Recommended for cold and hot water service within the specified temperature range plus a variety of dilute acids, oil-free air and many chemical services. NOT RECOMMENDED FOR PETROLEUM SERVICES.

Grade "T" nitrile

Nitrile (Orange color code). Temperature range -20°F to +180°F/-29°C to +82°C. Recommended for petroleum products, air with oil vapors, vegetable and mineral oils within the specified temperature range. Not recommended for hot water services over +150°F/+66°C or for hot dry air over +140°F/+60°C.

Grade "O" Fluoroelastomer

Fluoroelastomer (Blue color code). Recommended for many oxidizing acids, petroleum oils, halogenated hydrocarbons, lubricants, hydraulic fluids, organic liquids and air with hydrocarbons to +300°F/+149°C. NOT RECOMMENDED FOR HOT WATER SERVICES.

¹ Services listed are General Service Recommendations only. It should be noted that there are services for which these gaskets are not recommended. Reference should always be made to the latest Victaulic Gasket Selection Guide for specific gasket service recommendations and for a listing of services which are not recommended.

Stem Seal:

Standard: EPDM

Optional: Nitrile

Bottom Cover Plate O-ring:

Standard: EPDM

Optional: Nitrile

Cover Plate: Steel

Gasket Retaining Segment: 304 stainless steel

Seal Retaining Screw: 304 stainless steel

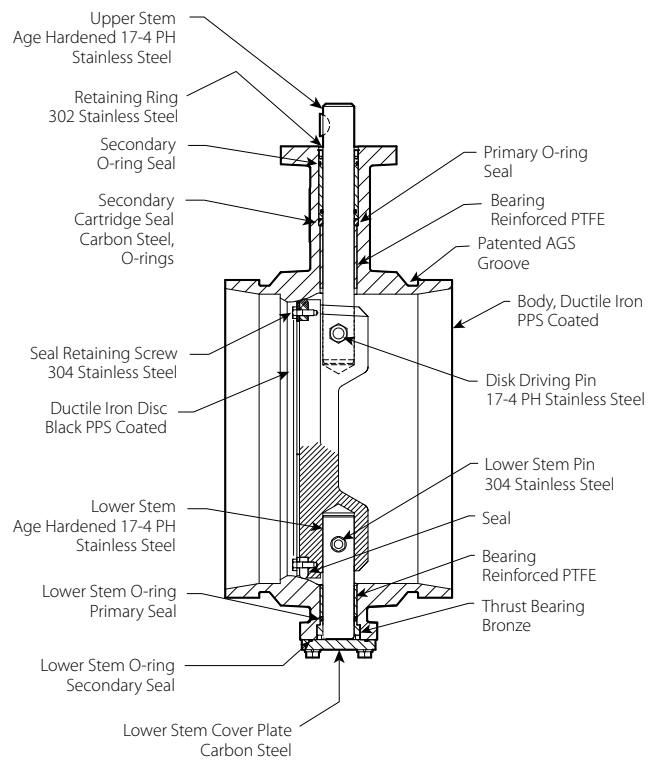

Exaggerated for Clarity

Stem-Upper/Lower: Stainless steel age hardened 17-4 PH

Bearing: Reinforced PTFE

Thrust Washer: Bronze

Disc Driving Pin: 17-4 PH stainless steel

Dimensions:

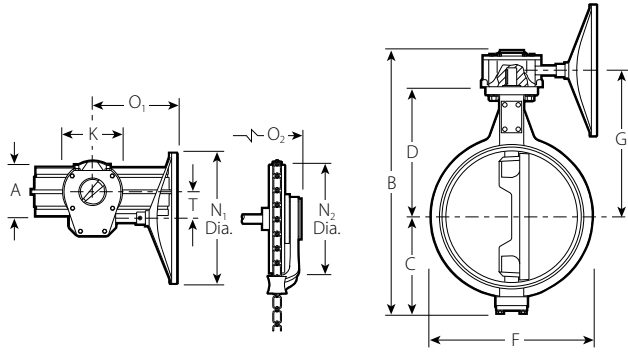

Size		Dimensions												Number Turns to close	Approx. Weight Each lbs. kg
Nominal Size inches mm	Actual Outside Diameter inches mm	End to End A inches mm	Overall Height B inches mm	C inches mm	D inches mm	F inches mm	G inches mm	K inches mm	Handwheel		Chain Wheel		T inches mm		
									N ₁ inches mm	O ₁ inches mm	N ₂ inches mm	O ₂ inches mm			
14 350	14.000 355.6	10.00 254	26.25 667	9.75 248	12.88 327	16.00 406	14.63 372	7.88 200	19.75 502	12.88 327	21.50 546	16.00 406	3.00 76	9.5	156.0 70.8
16 400	16.000 406.4	10.50 267	29.00 737	11.00 279	14.13 359	18.00 457	16.00 406	8.75 222	19.75 502	14.38 365	21.50 546	17.50 445	3.38 86	13.75	201.0 91.2
18 450	18.000 457.0	11.00 279	32.25 819	12.38 314	15.00 381	20.00 508	17.25 438	11.25 286	27.63 702	15.63 397	30.00 762	18.75 476	4.38 111	21	269.5 122.2
20 500	20.000 508.0	11.50 292	36.25 921	14.13 359	16.13 410	23.00 584	18.25 464	11.25 286	27.63 702	18.50 470	30.00 762	21.63 549	5.38 137	52	384.2 174.3
24 600	24.000 610.0	12.00 305	42.50 1080	16.13 410	20.13 511	26.75 679	22.50 572	14.63 372	27.63 702	20.50 521	30.00 762	23.63 600	5.38 137	79.25	605.0 274.4

Dimensions:

Size		Dimensions										Approx. Weight Each lbs. kg
Nominal Size inches mm	Actual Outside Diameter inches mm	End to End A inches mm	Overall Height B inches mm	C inches mm	D inches mm	E inches mm	F inches mm	G inches mm	Mounting			
									H ₁ inches mm	H ₂ inches mm	I Dia.	
14 350	14.000 355.6	10.00 254	25.00 635	9.75 248	12.88 327	1.25 32	16.00 406	15.38 391	5.00 127	0.58 15	1.38 35	125.0 56.7
16 400	16.000 406.4	10.50 267	28.00 711	11.00 279	14.13 359	2.00 51	18.00 457	17.00 432	5.00 127	0.58 15	1.50 38	153.0 69.4
18 450	18.000 457.0	11.00 279	30.00 762	12.38 314	15.00 381	2.63 59	20.00 508	17.63 448	5.00 127	0.58 15	1.75 45	199.0 90.3
20 500	20.000 508.0	11.50 292	33.25 845	14.13 359	16.13 410	3.50 89	23.00 584	19.13 486	5.50 140	0.67 17	2.00 51	285.0 129.3
24 600	24.000 610.0	12.00 305	40.00 1016	16.13 410	20.13 511	5.25 133	26.75 679	24.00 610	6.50 165	0.84 21	2.25 57	451.0 204.6

† **MOUNTING KEY:**

- 14"/350 mm – 3/8 Sq. x 1 7/8
- 16"/400 mm – 3/8 Sq. x 2 1/2
- 18"/450 mm – (2) 3/8 Sq. x 2
- 20"/500 mm – (2) 1/2 Sq. x 2 1/4
- 24"/600 mm – (2) 5/8 Sq. x 3

IMPORTANT NOTES:

Dimensions provided without operator are for sizing data only. The AGS Vic-300 should never be installed without operators.

The AGS Vic-300 valves have longer E to E dimensions and AGS groove dimensions and cannot be used to replace existing Series 706 butterfly valves.

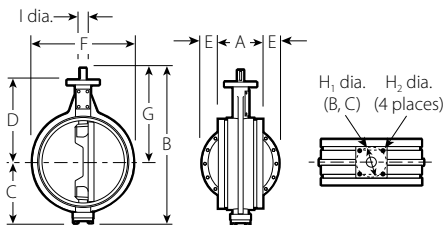

Performance:

The AGS Vic-300 butterfly valves have excellent flow characteristics due to the narrow profile disc design with separate upper and lower stems.

C_v/K_v values for flow of water at +60°F/+16°C with various disc positions are shown in the tables below.

Formulas for C_v values

$\Delta P = Q^2/C_v^2$

$Q = C_v \times \sqrt{\Delta P}$

Where:

Flow Coefficient	C_v
Q (Flow)	GPM
ΔP (Pressure Drop)	psi

Formulas for K_v values











$\Delta P = Q^2/K_v^2$

$Q = K_v \times \sqrt{\Delta P}$

Where:

Flow Factor	K_v
Q (Flow)	m ³ /hr
ΔP (Pressure)	bar

Size		C_v	K_v
Nominal Size	Actual Outside Diameter	(Full Open)	(Full Open)
inches	inches		
mm	mm		
14 350	14.000 355.6	9360	7984
16 400	16.000 406.4	12400	10577
18 450	18.000 457.0	15900	13562
20 500	20.000 508.0	19800	16889
24 600	24.000 610.0	28900	24651

Size		Flow Coefficients – C_v/K_v									
		Disc Position (Degrees open)									
Nominal Size	Actual Outside Diameter	70		60		50		40		30	
											
inches	inches	C_v	K_v	C_v	K_v	C_v	K_v	C_v	K_v	C_v	K_v
14 350	2.375 60.3	4350	3711	3040	2593	2130	1817	1490	1271	900	768
16 400	2.875 73.0	5680	4845	3940	3361	2730	2329	1880	1604	1130	963.89
18 450	3.500 88.9	7200	6142	4970	3386	3420	2917	2340	1996	1400	1194
20 500	4.500 114.3	8810	7515	6010	5127	4080	3480	2740	2337	1610	1373
24 600	8.625 219.1	12700	1083	8580	7319	5760	4913	3800	3241	2210	1885

Flow Characteristics:

The chart below expresses the flow of water at 65°F/18°C through a full open valve.

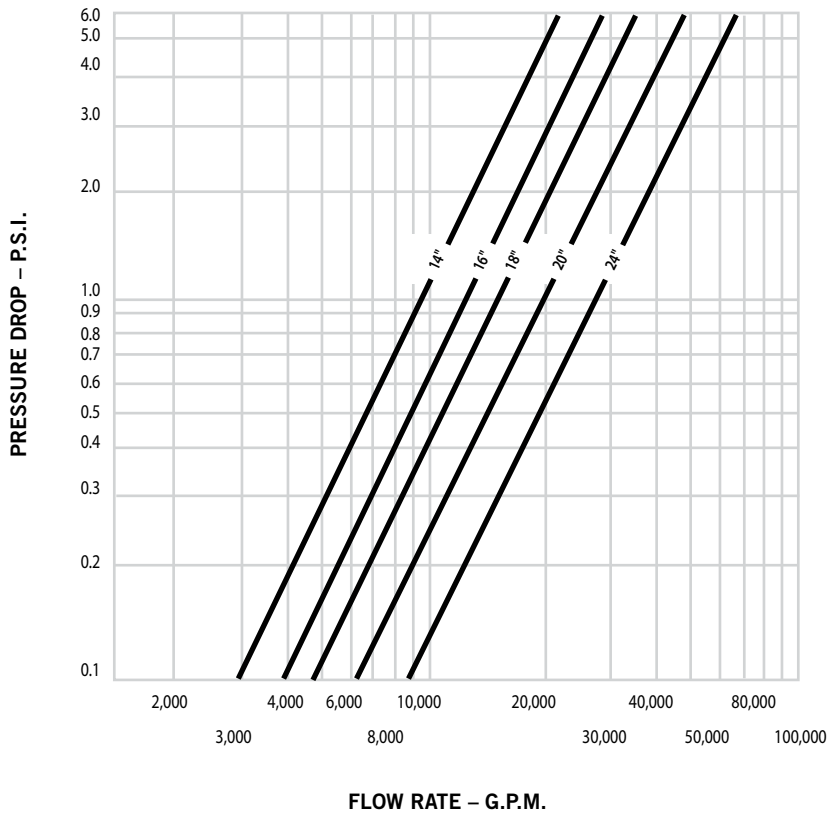

Maximum Allowable Pressure Drops:

Size		Maximum Allowable Pressure Drops – psi/kPa					
Nominal Size inches mm	Actual Outside Diameter inches mm	Disc Position (Degrees Open)					
		90°	70°	60°	50°	40°	30°
14 350	14.000 355.6	0.54 4	2.5 17	5.1 35	10 69	21 145	59 407
16 400	16.000 406.4	0.54 4	2.6 18	5.4 37	11 76	24 165	65 448
18 450	18.000 457.0	0.54 4	2.6 18	5.5 38	12 83	25 172	70 483
20 500	20.000 508.0	0.54 4	2.7 19	5.8 40	13 90	28 193	81 558
24 600	24.000 610.0	0.54 4	2.8 19	6.1 42	14 97	31 214	82 565



WARNING

Failure to follow instructions, operating restrictions and warnings can result in serious personal injury and damage to the equipment.

- Do not exceed the maximum allowable pressure drop (psi/kPa) as described in the table above.

Maximum Allowable Flow Rates:

The maximum allowable flow rate has been determined using the maximum allowable pressure drop and the CV values. The AGS Vic-300 butterfly valves are rated to the full valve working pressure for ON-OFF service. To ensure proper operation of the valves when the valves are open, flow through the valves should not exceed the values in the tables below.

Size		Maximum Allowable Flow Rates – gpm/lpm					
Nominal Size inches mm	Actual Outside Diameter inches mm	Disc Position (Degrees Open)					
		90°	70°	60°	50°	40°	30°
14 350	14.000 355.6	6880 26050	6890 26090	6900 26130	6910 26160	6910 26160	6890 26090
16 400	16.000 406.4	9120 34530	9120 34530	9130 34570	9140 34610	9130 34570	9140 34610
18 450	18.000 457.0	11700 44300	11700 44300	11700 44300	11700 44300	11700 44300	11800 44680
20 500	20.000 508.0	14600 55280	14600 55280	14600 55280	14600 55280	14600 55280	14600 55280
24 600	24.000 610.0	21300 80650	21300 80650	21200 80270	21200 80270	21200 80270	17400 65880

 **WARNING**

Failure to follow instructions, operating restrictions and warnings can result in serious personal injury and damage to the equipment.

- Do not exceed the maximum allowable pressure drop (psi/kPa) as described in the table above.

Valve Torque Requirements:

AGS Vic-300 valves have low torque requirements for operating the valve. This results in less manual effort, smaller gear operators or smaller actuators to open and close the valve.

Size		Operation Torques Inch Pounds psi/Newton Meters per kPa					
Nominal Size inches mm	Actual Outside Diameter inches mm	Disc Position (Degrees Open)					
		90°	70°	60°	50°	40°	30°
14 350	14.000 355.6	620 10.2	460 7.5	270 4.4	140 2.3	110 1.8	90 1.5
16 400	16.000 406.4	970 15.9	710 11.6	420 6.9	220 3.6	160 2.6	130 2.1
18 450	18.000 457.0	1430 23.5	1050 17.2	620 10.2	330 5.4	240 3.9	200 3.3
20 500	20.000 508.0	2050 33.6	1500 24.6	890 14.6	470 7.7	340 5.6	280 4.6
24 600	24.000 610.0	3700 60.7	2700 44.3	1600 26.2	830 13.6	600 9.8	490 8.0

 **WARNING**

Failure to follow instructions, operating restrictions and warnings can result in serious personal injury and damage to the equipment.

- Do not exceed the maximum allowable pressure drop (psi) as described in the table above.

Valve Torque Requirements:

Source:

These torque values were derived from test data with non-lubricated valves in water at ambient temperatures with EPDM seals. For other material and service conditions, apply a suitable service factor.

Torque Factors:

All torque values are for normal conditions (i.e. the valve is operated at least once a quarter, disc corrosion is expected to be minor, the media is clean and non-abrasive, and the chemical effects upon the elastomer are minor).

Typical fluid torque factors commonly used in the industry are:

Water: 1.0; Lubricated service: 0.8; Dry gases: Lubricated nitrile “T” seat seals are recommended for dry gases wherever chemically appropriate. See material torque factor below.

Material Torque Factors:

“E” = 1.0; “O” = 1.2; “T” = 1.0

Cycling Factor:

Torque will typically increase as the valve is cycled. A factor of 1.5 should be applied for the first 5000 cycles and another 1.5 applied for all additional cycles. The higher number should be used if there are more than one cycle per hour.

Actuation Factor:

There are no actuation safety factors applied. A factor consistent with the consequences of not actuating should be applied. A minimum factor of 1.2 is recommended for directly actuated valves and 1.5 for 3-way assemblies.

Combining Torque Factors:

When multiple torque factors apply, they are combined by multiplying them. Example: For an EPDM seal and a 5000 cycle factor the combined factor would be 1.0 x (1.5) = 1.5.

Note:

Under certain high flow conditions, the hydrodynamic torque can exceed the seating torque. Large butterfly valves are not recommended for use in a free discharge condition, such as filling an empty line with fluid at the full rated pressure.

Contact Victaulic for other services.

Valve Torque Requirements:

Size		Seating/Unseating Torque Inch Pounds/Newton Meters						
Nominal Size inches mm	Actual Outside Diameter inches mm	Differential Pressure - psi/kPa						
		0/0	50/345	100/690	150/1035	175/1200	235/1620	300/2070
14 350	14.000 355.6	2970 335.6	3830 432.7	4600 519.8	5000 565.0	5500 621.5	7400 836.2	9660 1091.6
16 400	16.000 406.4	3875 437.8	4820 544.6	5620 635.1	6000 678.0	6500 734.5	10000 1130.0	15200 1717.6
18 450	18.000 457.0	4900 553.6	6005 678.5	6820 770.7	7100 802.3	7500 847.5	14000 1582.0	25000 2825.0
20 500	20.000 508.8	6060 684.7	7310 825.9	10200 1152.6	14000 1582.0	17500 1977.5	27500 3107.5	46400 5243.2
24 600	24.000 610.0	8720 985.2	10130 1144.5	14800 1672.4	20000 2260.0	24000 2712.0	48000 5424.0	102000 11526.0

Numbering System:

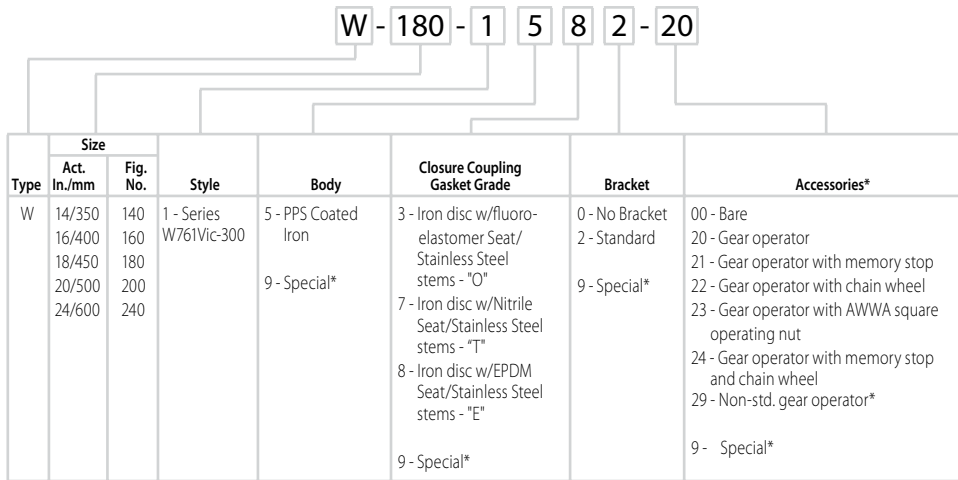

*Details required

Installation

Reference should always be made to the [I-100 Victaulic Field Installation Handbook](#) for the product you are installing. Handbooks are included with each shipment of Victaulic products for complete installation and assembly data, and are available in PDF format on our website at www.victaulic.com.

Warranty

Refer to the Warranty section of the current Price List or contact Victaulic for details.

Note

This product shall be manufactured by Victaulic or to Victaulic specifications. All products to be installed in accordance with current Victaulic installation/assembly instructions. Victaulic reserves the right to change product specifications, designs and standard equipment without notice and without incurring obligations.

Trademarks

Victaulic® and VIC®-300 are registered trademarks of Victaulic Company.